

# Trueness of Crown Preparation Dies in Dental Models: An In Vitro Assessment of Digital and Analog Workflows

Liudas Auskalnis, DDS

Department of Prosthodontics, Institute of Odontology, Faculty of Medicine, Vilnius University, Vilnius, Lithuania.

Mykolas Akulauskas, MS

Biomedical Engineering Institute, Kaunas University of Technology, Kaunas, Lithuania.

Darius Jegelevicius, PhD

Biomedical Engineering Institute and Department of Electronics Engineering, Kaunas University of Technology, Kaunas, Lithuania.

Vygandas Rutkunas, DDS, Dipl. Prosth, PhD

Department of Prosthodontics, Institute of Odontology, Faculty of Medicine, Vilnius University, Vilnius, Lithuania.

**Purpose:** To assess crown die trueness using additive manufacturing (AM) based on intraoral scanning (IOS) data and compare it with stone models. **Materials and Methods:** Crown dies with four finish line types—equigingival shoulder (SAE), subgingival shoulder (SAS), equigingival chamfer (CAE), and subgingival chamfer (CAS)—were incorporated into a reference model and scanned with a coordinate measurement machine (CMM;  $n = 1$  scan). Trios4 (3Shape) scans generated a second reference dataset (IOS;  $n = 10$  scans). Using scans, crown dies were produced with two different 3D printers (MAX UV385 [Asiga] and NextDent 5100 [3DSYSTEMS];  $n = 10$  per system). Stone dies were created from conventional impressions ( $n = 10$ ). Specimens were digitized with a laboratory scanner (E4, 3Shape). Trueness was evaluated with Geomagic Control X (3DSYSTEMS). Data analysis was done using Shapiro-Wilk, Levene, ANOVA, and  $t$  tests ( $\alpha < .05$ ). **Results:** All crown dies fell within the clinically acceptable trueness range ( $150 \mu\text{m}$ ). IOS exhibited significantly lower ( $P < .05$ ;  $\Delta \leq 21.7 \mu\text{m}$ ) or similar trueness compared to stone models. Asiga dies demonstrated similar and NextDent significantly lower marginal trueness than IOS ( $P < .05$ ;  $\Delta \leq 57.3 \mu\text{m}$ ). Most AM margin areas had significantly lower trueness than stone ( $P < .001$ ;  $\Delta \leq 57.2 \mu\text{m}$ ). Asiga outperformed NextDent ( $P < .001$ ). Shoulder trueness surpassed chamfer in optical scans ( $P = .01$ ). Finish line design and gingiva location did not have a significant impact on AM and stone models ( $P > .05$ ). **Conclusions:** Combining IOS and AM achieves clinically acceptable crown die trueness for single molar teeth. The choice of AM device is critical, with Asiga outperforming NextDent. Finish-line design has an impact on optical scans. Finish-line design and marginal gingiva location have little effect on AM trueness. *Int J Prosthodont* 2024;37(suppl):s89–s98. doi: 10.11607/ijp.8985

The evolution of digital dentistry is particularly evident in the utilization of additive manufacturing (AM) to fabricate dental models.<sup>1–3</sup> An important component fabricated through AM is the die for tooth preparation, which is used in the manufacturing of tooth-supported fixed dental prostheses (FDPs).<sup>4</sup> FDPs serve a vital role in restoring oral function and esthetics for patients with compromised or missing dentition.<sup>5,6</sup> The trueness of these dies significantly influences the overall success and effectiveness of the subsequent prosthesis.

The dental industry has traditionally relied on manual fabrication of dental models, including preparation dies, using stone and physical impressions. This method, though able to achieve notable accuracy, has been fraught with challenges. The selection of impression material and tray, the need for proper disinfection, transportation logistics, and the potential discomfort experienced by patients all contribute to the drawbacks of conventional impressions.<sup>7</sup> Further, producing dental stone models is a labor-intensive

Correspondence to:  
Dr Liudas Auskalnis,  
liudas.auskalnis@gmail.com

Submitted January 28, 2024;  
accepted February 2, 2024.  
©2024 by Quintessence  
Publishing Co Inc.

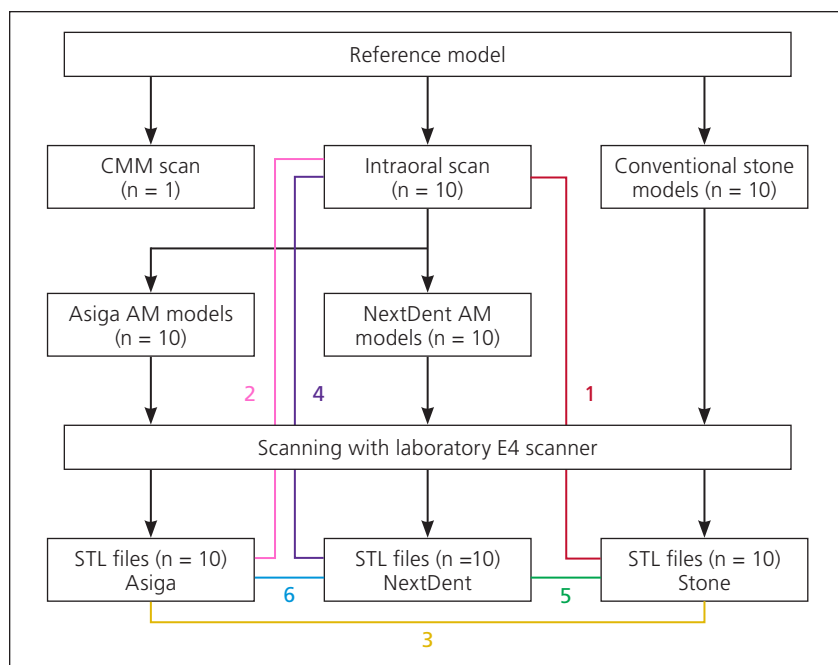

**Fig 1** Study scheme. Colored lines represent comparisons between groups.

process, and such models are susceptible to breakage and deformation.<sup>8–10</sup> These physical models also pose storage concerns, as they require considerable space.<sup>11</sup> In contrast, the emergence of a digital alternative employing intraoral scanning (IOS) and AM devices offers numerous advantages. These include improved patient comfort,<sup>12</sup> time efficiency,<sup>13</sup> convenient storage and management,<sup>8</sup> and reduced waste generation.<sup>14</sup>

As fully digital workflows become more widespread in the dental industry, there is still considerable value in a hybrid approach that combines digital techniques with physical models, particularly for tooth-supported FDPs.<sup>15,16</sup> Physical models are used to achieve proper contouring and finishing of restorations, and they facilitate the evaluation of marginal fit, occlusion, and proximal contacts.<sup>17</sup> These models also play a crucial role in the fabrication of manually veneered FDPs, offering enhanced esthetics.<sup>2</sup> Irrespective of whether the workflow is analog, digital, or partially digital, the need for physical dental models persists.<sup>18</sup>

Marginal and internal fit influence the longevity of full-contour FDPs.<sup>19,20</sup> Therefore, a high degree of accuracy is essential in producing the dies. Inaccurate dies can result in ill-fitting restorations, leading to biologic (plaque accumulation, microleakage, pulpal inflammation, caries) and mechanical (loss of retention, reduced resistance to fracture) complications.<sup>21,22</sup>

The digital workflow process begins with an intraoral scan. Despite the advancements in scanning technology, multiple factors can affect the accuracy of these scans, including the scanner's hardware, operator skill, and patient-specific conditions.<sup>23–25</sup> In addition, it has been shown that both the finish-line design of the tooth preparation and marginal gingiva location can affect the accuracy of these optical scans.<sup>26–28</sup> These inaccuracies can introduce errors into the subsequent stages of the workflow, impacting the trueness of the produced crown dies, and subsequently, the fit of the final restoration.<sup>29,30</sup>

A range of AM technologies are available for the production of preparation dies, including material jetting and vat-polymerization-based

technologies, such as stereolithography (SLA), digital light processing (DLP), liquid crystal display (LCD), and continuous liquid interface production (CLIP). Vat-polymerization-based technologies (SLA, DLP, LCD, and CLIP) work by curing or solidifying photosensitive resin in a vat or tank, layer-by-layer, using light sources such as lasers or projectors. Material jetting, on the other hand, selectively deposits droplets of photopolymer materials onto a build platform, which are then cured by ultraviolet (UV) light.<sup>31–33</sup> The influence of the chosen AM technology, along with the combined effect of IOS and AM, on the trueness of fabricated crown dies necessitates further investigation.<sup>34,35</sup> Moreover, many current studies examining the accuracy of digital workflows lack a control group of stone models.<sup>36–39</sup> The incorporation of a stone control group is crucial to thoroughly assess the clinical applicability and reliability of digital techniques in restorative dentistry.

Considering these factors, this in vitro study investigates the trueness of crown dies fabricated through AM. Specifically, the study explores the impacts of IOS, two distinct crown finish-line designs (chamfer and rounded shoulder), marginal gingiva locations (equigingival and 0.5 mm subgingival), and the use of two different AM devices. The null hypothesis set for this study is that the trueness of digitally produced crown dies does not differ from that of conventionally produced stone crown dies.

## MATERIALS AND METHODS

An in vitro study was conducted to evaluate the trueness of the digitally and conventionally produced crown dies. The study scheme is shown in Fig 1.

### Reference Data Set

Initially, a crown die was digitally designed following Annex B from

**Fig 2** (a) Shoulder and (b) chamfer crown preparation margin designs.

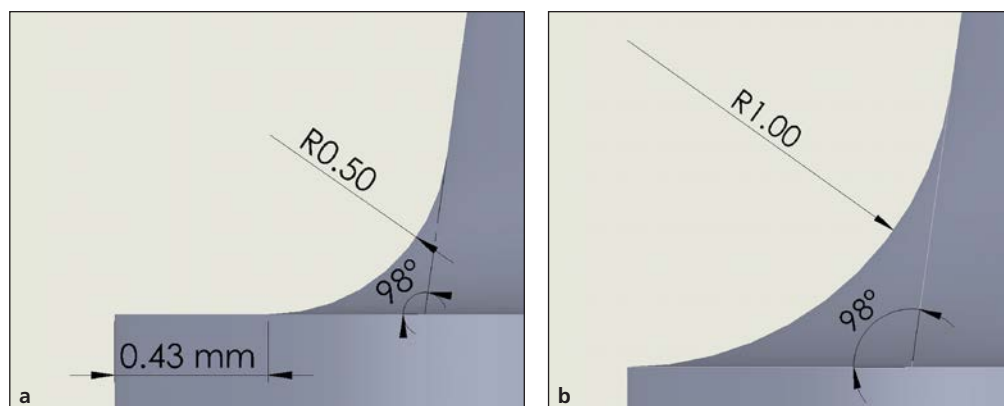

ISO 12836:2015.<sup>40</sup> The preparation margin circumferentially was divided into four equal parts, each with a different marginal gingiva location (either 0.5 mm subgingival or equigingival) and distinct finish-line designs (either chamfer or rounded shoulder). Each part of the preparation margin was placed in different sites of the die: distobuccal-equigingival shoulder area (SAE), mesiobuccal-subgingival shoulder area (SAS), mesiopalatal-subgingival chamfer area (CAS), and distopalatal-equigingival chamfer area (CAE). The design of these margins adhered to the study by Subasi et al<sup>41</sup>: The curvature radius (R) of the axiokingival internal line angle was set at 0.5 mm for the rounded shoulder margin and 1 mm for the chamfer. Both preparations had a width of 1 mm (Fig 2). Additional areas were isolated on the die: the axial wall (AW) and occlusal area (O). The design of the die, reaching a height of 8 mm from the lowest point of the margin, featured an 8-degree convergence angle and was surrounded by gingiva that included a sulcus with a width of 0.2 mm.

Subsequently, a partially dentate maxillary arch practice model (ANA-4, Frasco) was digitally scanned and modified. The previously designed crown die was incorporated into this reference model using computer-aided design (CAD) software (Solidworks 2016, Dassault Systèmes).

The resulting digital files facilitated AM of a physical reference model using a DLP device (MAX UV 385, Asiga) with a resin for dental models (DentaMODEL, Asiga). A removable flexible gingiva mask was fabricated separately (DentaGUM, Asiga), which simulated a retraction of 0.2 mm (Fig 3).

Finally, the reference model, with gingiva removed and the preparation margin exposed, was scanned using a coordinate measurement machine (CMM) equipped with an LC15Dx laser scanning head (ALTERA 10.7.6, Nikon). The resulting data, exported in a standard tessellation language (STL) file format, constituted a CMM dataset ( $n = 1$ ).

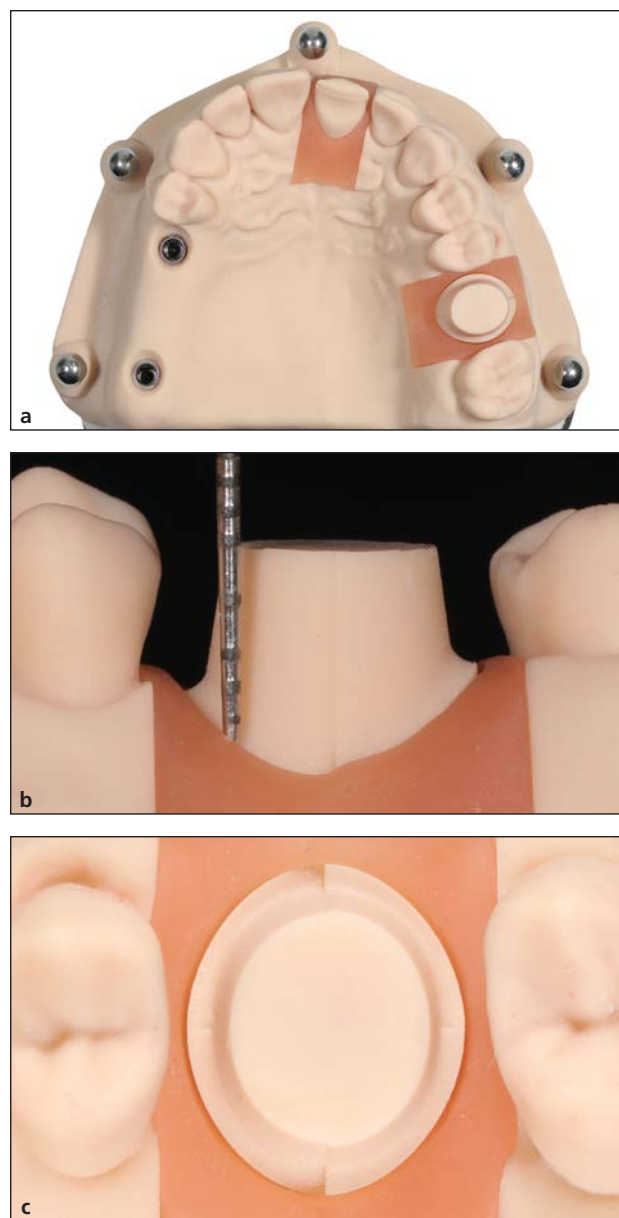

**Fig 3** (a) Maxillary reference cast, (b) crown die side view, and (c) crown die top view.

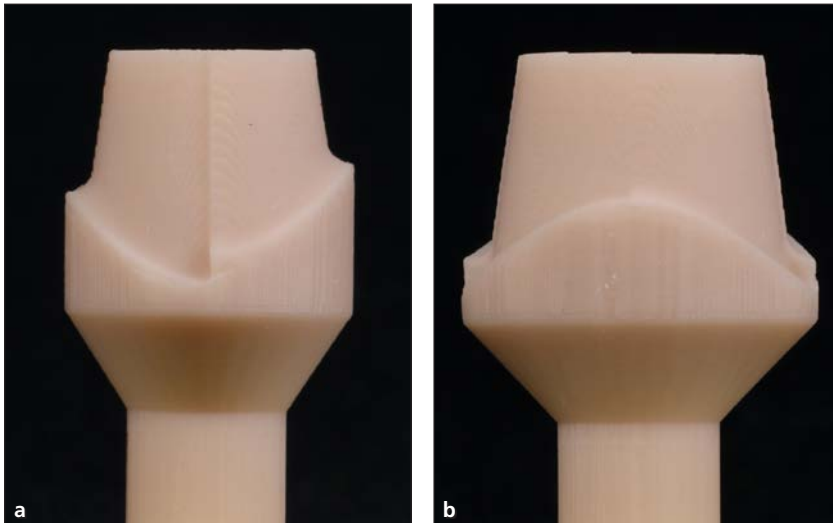

**Fig 4** (a) Front and (b) proximal sides of an Asiga AM crown die.

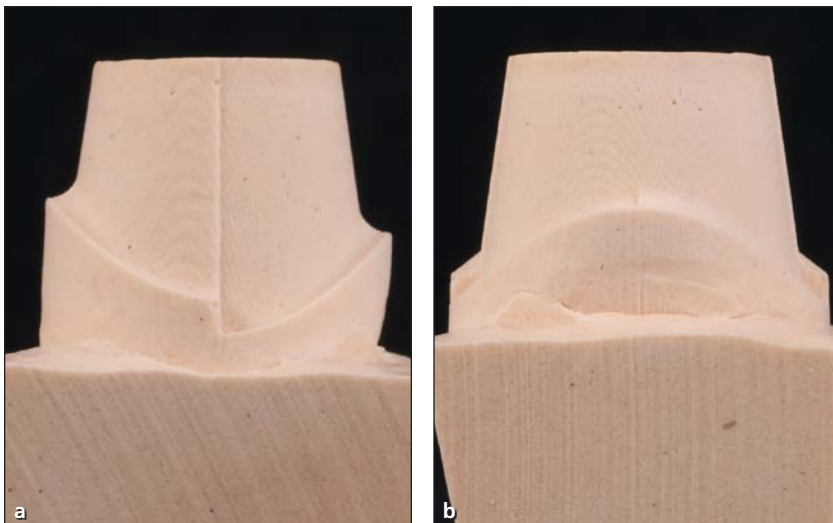

**Fig 5** (a) Front and (b) proximal sides of a stone crown die.

### Digital Workflow

Within 48 hours after CMM scanning, a gingiva replica was attached to the reference model, and optical scans (IOS;  $n = 10$ ) were captured using an intraoral scanner (Trios 4, version 20.1.3, 3Shape). Each scan was repeated in the same manner as recommended in the manufacturer's training videos.<sup>42</sup> After performing a complete arch scan, the crown preparation margin area was digitally erased with the trimming tool and rescanned with the Zoom feature enabled. The scanner underwent calibration every fifth scan.

The IOS data was then imported into dental software (Dental Designer 2021 and Model Builder 2021, 3Shape), and a single crown die was generated from each scan ( $n = 10$  total dies). The test dies were additively manufactured using two DLP devices: MAX UV385 and NextDent 5100 (3D Systems) ( $n = 10$  per group; total of 20 3D-printed dies; see Fig 1). DentaMODEL and Model 2.0 (3D Systems) resins were used, respectively.

Each die was positioned vertically in the center of the build platform with support structures and was manufactured in separate print jobs using a 50- $\mu\text{m}$  layer thickness. Both AM devices underwent calibration every fifth printing, and the AM and postprocessing of the resin models were conducted following the manufacturers' instructions (Fig 4). All resin models were stored in a light-proof compartment. A consistent room temperature of 21°C was ensured with the conditioning system during all manufacturing steps. Dies were then scanned using a calibrated laboratory scanner (E4, 3Shape), producing Asiga and NextDent datasets ( $n = 10$  each) in STL file format.

### Conventional Workflow

Immediately after IOS, conventional impressions of the reference model were taken using a one-step custom tray technique ( $n = 10$ ). A short period of time (48 hours) between conventional and optical scans minimized the impact of aging on the accuracy of the reference model.<sup>43</sup> Vinyl polysiloxane impression materials (Imprint 4 light and putty viscosities, 3M ESPE) were utilized for this purpose. Both the impression-taking and pouring processes adhered to the manufacturers' guidelines and used Type IV dental stone (GC Fujirock EP, GC). The waiting time for impression setting was twice as long to compensate for temperature differences between oral and room temperatures. Upon complete setting of the full-arch stone models, crown dies were retrieved ( $n = 10$ ) using a straight handpiece, diamond discs, and tungsten carbide burs (Fig 5). Samples with defects  $> 1 \text{ mm}^2$  were not included in the study. The crown dies were then scanned using the same calibrated laboratory scanner (E4), yielding the control Stone dataset ( $n = 10$ ) in STL file format.

### Measurements

Measurements of surface deviations on the crown dies were performed

**Fig 6** (a) Palatal and (b) buccal sides of the 3D surface measurements on the crown dies. AW = axial wall; CAE = equigingival chamfer area; CAS = subgingival chamfer area; O = occlusal area; SAE = equigingival shoulder area; SAS = subgingival shoulder area.

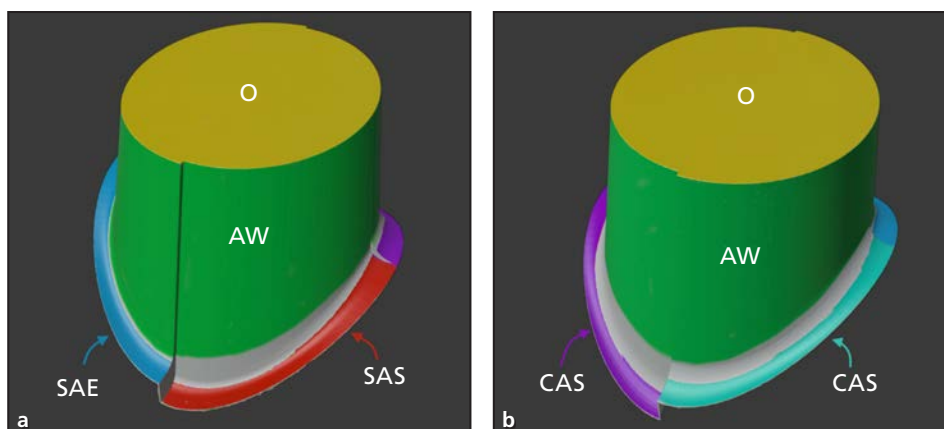

**Table 1** Trueness Unsigned Values

Reference	Group	Preparation margin					
		SAS	SAE	CAS	CAE	AW	O
CMM	IOS	32.8 (23.4)	31.8 (27.8)	42.4 (33.1)	38 (23.6)	45.5 (24.8)	58.9 (54.8)
	Stone	31.2 (28.3)	29.3 (27)	28.9 (23)	30.2 (29.9)	44.7 (21.2)	37.3 (36.4)
	Asiga	43.2 (40.7)	29.9 (25.1)	39.7 (37.9)	33 (31.5)	34.8 (18.9)	37.1 (36.8)
	NextDent	69.7 (62.5)	105.3 (38.2)	90.4 (44.5)	59.1 (42.6)	30.9 (25.6)	38.8 (25.5)
IOS	Asiga	35.1 (25.6)	33 (24.8)	26.9 (24)	45.8 (32.5)	22.1 (21.2)	18.8 (16.3)
	NextDent	75.8 (57)	100.3 (33.1)	104.2 (49.3)	90.8 (52.7)	36.2 (29.2)	34.1 (27.5)

Data are shown as root mean square (SD).

across six specific regions: O, AW, CAS, SAS, CAE, and SAE (Fig 6). First, all digital models were imported into the metrology software (Geomagic Control X, 3D Systems), where all surfaces were removed except the crown's. The models were then manually prealigned and best-fit to the crown's die CAD model (with sampling ratio of 100%, iteration count of 100, and average deviation set to "Auto") and exported as separate trimmed crown models in the form of STL files. Second, the trimmed crown and CAD models were imported into a 3D graphic modeling software (Blender 2.91). Using Blender tools, curves resembling the boundaries of each region were drawn on the CAD model's surface and projected onto each crown model, ensuring consistent region extraction, which was achieved using the 'knife project' tool. Subsequently, all separate regions were imported back into Geomagic Control X, where models for each selected group were best-fit (using the previously established settings), and their 3D deviations were analyzed. For further data analysis, the aggregated 3D deviation was represented using the root mean square (RMS) and SD.

### Data Analysis

Statistical software (SPSS version 27.0, IBM) was used to analyze data. Comparisons of different regions were made between two distinct groups with selected references.

Normality of each group was tested using Shapiro-Wilk test. Levene's test was used to verify homogeneity of variance between groups. To estimate the difference between selected groups, *t* test was used. Two-way ANOVA was performed to determine the effects of finish-line design and marginal gingival location on preparation margin trueness for two groups: IOS (CMM) and Stone (CMM). Further, three-way ANOVA was used to assess the influence of the aforementioned factors, along with the type of AM device, on preparation margin trueness in two AM groups: NextDent and Asiga. If statistically significant results were obtained, a further analysis was conducted using Tukey post-hoc test. For all statistical tests,  $\alpha = .05$  was chosen as the threshold for statistical significance. Descriptive statistics (mean  $\pm$  SD) were calculated for all data in surface-region deviation groups. Trueness was similar between the groups when  $P > .05$  and significantly different when  $P < .05$ . The difference of deviations between groups was marked  $\Delta$ .

### RESULTS

The results of the 3D surface area, along with the corresponding statistical tests, are presented in Tables 1 to 3 and Fig 7. The results of all measurements were within the range of 150  $\mu\text{m}$  (Table 1).

**Table 2** Two-Way and Three-Way ANOVA Results of Evaluated Factors

	Two-way ANOVA				Three-way ANOVA			
	IOS (CMM)		Stone (CMM)		AM (IOS)		AM (CMM)	
	F	P	F	P	F	P	F	P
Finish-line design	8.40	.01*	0.2	.69	0.84	.36	1.50	.22
Marginal gingiva location	0.97	.33	0.03	.86	1.17	.28	0.55	.46
Finish-line design × marginal gingiva location	0.38	.54	0.9	.35	0.43	.52	8.16	.01*
3D printer	–	–	–	–	80.25	< .001*	71.34	< .001*
3D printer × finish-line design	–	–	–	–	0.31	.58	1.40	.24
3D printer × marginal gingiva location	–	–	–	–	0.05	.83	1.32	.25
Finish-line design × marginal gingiva location × 3D printer	–	–	–	–	5.22	.03*	12.06	< .001*

\*Statistically significant ( $P < .05$ ).

**Table 3** Comparisons Between Groups

	Compared groups (reference)		Preparation margin							
			SA		CA		AW		O	
	Group 1	Group 2	P	$\Delta$ , $\mu\text{m}$	P	$\Delta$ , $\mu\text{m}$	P	$\Delta$ , $\mu\text{m}$	P	$\Delta$ , $\mu\text{m}$
1	Stone (CMM)	IOS (CMM)	.41	–2.0	< .001*	–10.7	.75	–0.7	< .001*	–21.7
2	Asiga (CMM)	IOS (CMM)	.13	4.3	.07	–3.9	< .001*	–10.7	< .001*	–21.8
	Asiga (IOS)	IOS (CMM)	.66	1.7	.29	–3.9	< .001*	–23.4	< .001*	–40.2
3	Asiga (CMM)	Stone (CMM)	.01	6.3	< .001*	6.8	< .001*	–9.9	.91	–0.2
4	NextDent (CMM)	IOS (CMM)	< .001*	55.2	< .001*	34.5	< .001*	–14.6	< .001*	–20.1
	NextDent (IOS)	IOS (CMM)	< .001*	55.8	< .001*	57.3	< .001*	–9.3	< .001*	–24.8
5	NextDent (CMM)	Stone (CMM)	< .001*	57.2	< .001*	45.2	< .001*	–13.8	.67	1.6

A positive difference ( $\Delta$ ) shows higher deviations of Group 1 (Group 1 – Group 2 =  $\Delta$ ). The table does not include an insignificant marginal gingiva location factor.

\*Statistically significant ( $P < .05$ ).

### Effect of Finish-Line Design: Chamfer vs Rounded Shoulder

For the optical scans (reference CMM), the finish-line design had a significant effect on the trueness of the crown preparation margin ( $P < .05$ , Table 2). The rounded shoulder area (SA) had better trueness than the chamfer area (CA) (see Table 1). In contrast, the preparation margin areas in the AM (reference IOS) and stone crown dies (reference CMM) were not significantly affected by the finish-line design ( $P > .05$ , see Table 2).

### Effect of Marginal Gingiva Location: Equigingival vs 0.5 mm Subgingival

The preparation margin areas in the IOS, AM, and stone crown dies (reference CMM) were not significantly

affected by the marginal gingiva location ( $P > .05$ , see Table 2). Therefore, this factor was excluded from Table 3 and further comparisons.

### Effect of AM Device: Asiga vs NextDent

To evaluate the effect of AM device, Asiga and NextDent datasets were compared, while IOS was used as a mutual reference. Three-way ANOVA and descriptive statistics showed that Asiga crown dies had significantly greater trueness than NextDent ( $P < .001$ ; see Tables 1 and 2).

### Optical Scans vs Stone Models (Reference: CMM)

The surface deviation analysis revealed that crown dies in optical scans exhibited significantly lower trueness in the CA and O regions compared to stone dies

**Fig 7** Visualization of crown die deviations in different regions, shown as mean (position on the line) and standard deviation (size of the circle).

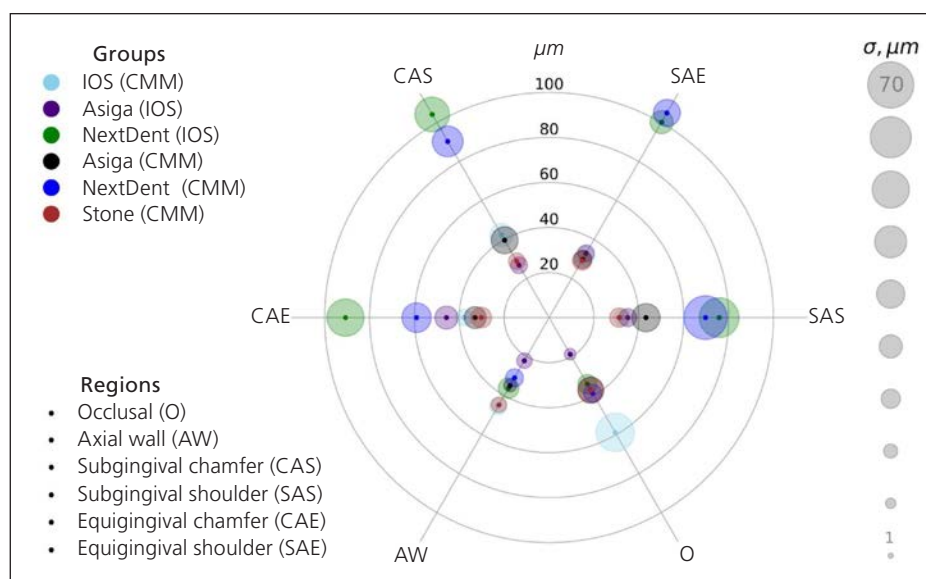

( $P < .001$ ,  $\Delta \leq 21.7 \mu\text{m}$ ; see Table 3). In contrast, no statistically significant differences were observed in the SA and AW regions ( $P > .05$ ,  $\Delta \leq 2.0 \mu\text{m}$ ).

#### Optical Scans vs AM Models (Reference: CMM)

Asiga and NextDent crown dies exhibited significantly greater trueness in the AW and O regions compared to optical scans ( $P < .001$ ,  $\Delta \leq 21.8 \mu\text{m}$ ; see Table 3). However, a notable difference was observed between the two AM devices on the trueness of the preparation margin: Crown dies produced with Asiga did not significantly differ from the optical scans ( $P > .05$ ,  $\Delta \leq 4.3 \mu\text{m}$ ), while preparation margin areas of NextDent dies were consistently less accurate than those captured by IOS ( $P < .001$ ,  $\Delta \leq 55.2 \mu\text{m}$ ).

#### Deviations from Optical Scan-Making (Reference: CMM) and AM (Reference IOS)

An additional aim of the present study was to compare the deviations introduced in each manufacturing step by utilizing different reference points. The IOS data, with the reference set as CMM, allowed the assessment of deviations introduced by the intraoral scanner, while the Asiga and NextDent data sets, with the reference set as IOS, represented the deviations introduced during AM.

The surface analysis of crown dies revealed significant differences between IOS and AM. Specifically, in AW and O areas, the IOS introduced significantly greater deviations compared to AM with both MAX UV385 and NextDent 5100 devices. However, when comparing the deviations in preparation margin areas, the results varied. Comparing the Asiga (IOS) and IOS (CMM) groups, the introduction of deviations was not significantly different ( $P > .05$ ,  $\Delta \leq 3.9 \mu\text{m}$ ; see Table 3). On the other hand,

when comparing the NextDent (IOS) and IOS (CMM) groups, AM with NextDent 5100 introduced significantly higher deviations in all preparation margin areas ( $P < .001$ ,  $\Delta \leq 57.3 \mu\text{m}$ ).

#### AM Models vs Stone Models (Reference: CMM)

Significant differences were observed in almost all regions of crown dies when comparing the Stone, Asiga, and NextDent groups, with the CMM serving as a mutual reference. For both AM devices, the AW region exhibited significantly better trueness in AM models compared to stone models ( $P < .001$ ,  $\Delta \leq 13.8 \mu\text{m}$ ; see Table 3). The O region showed similar trueness between AM and stone models ( $P > .05$ ,  $\Delta \leq 1.6 \mu\text{m}$ ). However, NextDent crown dies exhibited lower trueness in preparation margin areas compared to stone models ( $P < .001$ ,  $\Delta \leq 57.2 \mu\text{m}$ ). Similarly, Asiga dies displayed lower CA trueness ( $P < .001$ ;  $\Delta = 6.8 \mu\text{m}$ ).

## DISCUSSION

This in vitro study compared the trueness of digital and analog workflows in producing physical crown dies, while also evaluating the influence of AM device, finish-line design, and marginal gingiva location on trueness. The results demonstrate that all specimens exhibited deviations within the range of  $150 \mu\text{m}$ . The null hypothesis, that the trueness of digitally produced crown dies does not differ from that of conventionally produced stone crown dies, was thus rejected.

When comparing optical scans obtained with Trios4 to stone dies, similar trueness was observed in SA and AW areas, but lower trueness was found in CA and O areas. SA showed significantly higher trueness in optical scans

compared to CA. These findings align with a previous study by Bernauer et al,<sup>28</sup> who also found that the accuracy of first molar crown dies was more favorable for a shoulder finish line rather than a 0.4-mm or 0.8-mm chamfer. This was evident with both tested IOS devices: Trios 3 Pod (3Shape) and Cerec Primescan AC (Dentsply Sirona).<sup>28</sup>

Regarding the effect of marginal gingiva location (equigingival or 0.5 mm subgingival) on the trueness of optical scans, no statistically significant differences were detected in the present study. However, Keeling et al<sup>13</sup> showed that the marginal gingiva location did affect the quality of optical scans. They found that equigingival margin had a significantly lower curvature value, indicating a more rounded edge, than the supragingival margin. It was suggested that IOS is unable to register the depth of the gingival sulcus and fills the gap with a horizontal surface. Other studies also reported significantly higher accuracy of supragingival margin compared to equigingival margin.<sup>14,28</sup> In the study by Bernauer et al,<sup>28</sup> all optical scans achieved high accuracy with mean values of 80% quantiles ranging from  $20 \pm 2 \mu\text{m}$  to  $50 \pm 5 \mu\text{m}$ . The lack of significant difference in the present study, also seen in the study by Koulivand et al,<sup>44</sup> may be attributed to the use of a different IOS device, simulated retraction of 0.2 mm, and evaluation of subgingival rather than supragingival margin. Therefore, to attain accurate optical scans, it is crucial to ensure adequate soft-tissue management and prepare supragingival margins wherever possible.

The present study also compared the trueness of optical scans and AM models. Results show that IOS introduces higher deviations in AW and O surfaces than AM. It appears that AM is capable of compensating for the deviations introduced by IOS in these surfaces, which are rather flat and directly visible. A possible explanation could be that AM models tend to shrink and warp due to incomplete layer polymerization and the need for postprocessing.<sup>45,46</sup> The results differ for the preparation margin areas. When using the Asiga device, the preparation margin trueness was similar to that of the optical scans. However, using the NextDent device introduced significantly higher deviations than IOS and reduced the trueness of the margin areas. To the best of the present authors' knowledge, there are no recent studies directly comparing the trueness of crown dies between optical scans and AM models. Thus, it can be concluded that carefully selected AM devices are capable of maintaining or even improving the trueness of crown dies.

Multiple conclusions can be drawn from the present study regarding the final trueness of crown dies produced with digital and conventional methods. AW and O areas in all models manufactured using IOS data and AM exhibited similar or even higher trueness than stone models. Additionally, SA in Asiga models had

similar trueness to stone models. However, all preparation margin areas of NextDent models and the CA of Asiga models had inferior trueness to stone models. The finish-line design did not significantly effect the trueness. These results show a small improvement compared to an older study by Park and Shin<sup>45</sup> in which volumetric differences of AM and conventionally produced crown dies were evaluated; the AM models in that study had significantly higher discrepancies than stone dies. However, it should be noted that their study did not evaluate the effect of IOS and instead used a laboratory scanner to obtain the optical scan. Park and Shin also observed a decreased curvature value (sharpness) of the preparation margin in AM models, similar to the findings of Keeling et al<sup>13</sup> with optical scans. The cause of the decreased curvature value, whether it was due to scanning with a laboratory scanner or the AM process itself, in Park and Shin's study is unclear.

The present study compared two DLP devices: Asiga and NextDent. In all selected regions, Asiga achieved higher trueness than NextDent. Similar conclusions regarding the influence of the selected AM device on the accuracy of crown dies were made by Johansson et al.<sup>37</sup> Those authors manufactured specimens, which represented a four-unit FDP model, using two AM devices and found most measurements to be within 200  $\mu\text{m}$ . EvoDent (UnionTech) performed more accurately than Desktop Digital Dental Printer (EnvisionTEC). In Park and Shin's study,<sup>45</sup> three different AM devices were compared, and significant volumetric differences were observed between the groups. The LC-3Dprint (NextDent) device, based on DLP-UV technology, produced crown dies with the highest trueness, followed by DLP-UV LED (ProMaker D35, Prodways), and finally PolyJet (Objet Eden260V, Stratasys).

Furthermore, the trueness of the crown die could be influenced by other AM-related factors, such as print orientation,<sup>47</sup> object position on the build platform,<sup>47</sup> layer thickness,<sup>36,48</sup> and selected resin.<sup>37</sup> Unkovskiy et al<sup>47</sup> suggested that central object placement on the platform with a 45-degree orientation produced the highest accuracy using a stereolithography-based AM device. Johansson et al<sup>37</sup> compared four different resins and found that a translucent resin (NextDent SG, 3D Systems), exhibited the highest trueness compared to other tested resins. One possible explanation is that the translucency of the material promotes a deeper curing process, as pigments and dyes can obstruct the passage of light through the material.

The present study has several limitations that should be considered. The evaluation was based on a conventional 1-mm crown preparation, warranting further investigation into the performance of digital systems with more conservative and biomimetic preparation types. The *in vitro* setting used herein may not fully replicate





the complexities of the in vivo oral environment, including the absence of saliva, blood, sulcus fluids, and tongue movement. A laboratory scanner might also introduce additional deviations, potentially impacting the reliability of the measurements and results. However, the manufacturer has specified a 4- $\mu\text{m}$  accuracy.<sup>49</sup> Additionally, the study's findings may have a reduced power of generalization due to the inclusion of a limited range of digital devices, including only one intraoral scanner and two AM devices utilizing the same DLP printing technology. These limitations emphasize the need for future research to address these factors and provide a more comprehensive understanding of digital workflows and their clinical applicability.

## CONCLUSIONS

Based on the findings of this in vitro study, the following conclusions can be drawn:

1. Finish-line design affects the trueness of optical scans but does not significantly influence the performance of the AM device.
2. The location of the marginal gingiva does not appear to have a significant effect on the trueness of optical scans, AM, and stone models.
3. Asiga outperformed NextDent in terms of trueness.
4. Trueness of optical scans in chamfer and occlusal areas was lower compared to stone models, while other regions exhibited similar levels of trueness.
5. Depending on the AM device, AM crown dies have similar or significantly lower trueness of preparation margin areas when compared to IOS.
6. Depending on the AM device, AM introduced a similar or significantly higher amount of deviations in the digital workflow compared to IOS.
7. Although axial wall and occlusal areas displayed similar trueness between AM and stone models, AM models generally exhibited significantly lower trueness in preparation areas than stone models.

## ACKNOWLEDGMENTS

The authors thank DIGITORUM research group and laboratory support for material preparation and data acquisition. The study supported in part by Lithuanian Business Support Agency (grant no. J05-LVPA-K-01-0055). The authors declare no conflicts of interest.

## REFERENCES

1. Tsolakis IA, Gizani S, Panayi N, Antonopoulos G, Tsolakis AI. Three-dimensional printing technology in orthodontics for dental models: A systematic review. *Child Basel Switz* 2022;9:1106.
2. Revilla-León M, Özcan M. Additive manufacturing technologies used for processing polymers: Current status and potential application in prosthetic dentistry. *J Prosthodont Off J Am Coll Prosthodont* 2019;28:146–158.
3. Czajkowska M, Walejewska E, Zadrożny Ł, et al. Comparison of dental stone models and their 3D printed acrylic replicas for the accuracy and mechanical properties. *Mater Basel Switz* 2020;13:4066.
4. Bukhari S, Goodacre BJ, AlHelal A, Kattadiyil MT, Richardson PM. Three-dimensional printing in contemporary fixed prosthodontics: A technique article. *J Prosthet Dent* 2018;119:530–534.
5. Leitão CIMB, Fernandes GV de O, Azevedo LPP, Araújo FM, Donato H, Correia ARM. Clinical performance of monolithic CAD/CAM tooth-supported zirconia restorations: Systematic review and meta-analysis. *J Prosthodont Res* 2022;66:374–384.
6. Gonzaga CC, Garcia PP, Wambier LM, Prochnow FHO, Madeira L, Cesar PF. Do tooth-supported zirconia restorations present more technical failures related to fracture or loss of retention? Systematic review and meta-analysis. *Clin Oral Investig* 2022;26:5129–5142.
7. Gedrimiene A, Adaskevicius R, Rutkunas V. Accuracy of digital and conventional dental implant impressions for fixed partial dentures: A comparative clinical study. *J Adv Prosthodont* 2019;11:271–279.
8. Rossini G, Parrini S, Castroflorio T, Deregibus A, Debernardi CL. Diagnostic accuracy and measurement sensitivity of digital models for orthodontic purposes: A systematic review. *Am J Orthod Dentofac Orthop* 2016;149:161–70.
9. Jin S, Kim D, Kim J, Kim W. Accuracy of dental replica models using photopolymer materials in additive manufacturing: In vitro three-dimensional evaluation. *J Prosthodont* 2019;28:e557–e562.
10. Szerszeri M, Tyrajski M, Surowiecki D, Poniewierski W, Górski B. Influence of disinfecting agents on the spatial dimensions of alginate mass impressions. *Postępy Hig Med Dośw* 2020;74:36–41.
11. Etemad-Shahidi Y, Qallandar OB, Evenden J, Alifui-Segbaya F, Ahmed KE. Accuracy of 3-dimensionally printed full-arch dental models: A systematic review. *J Clin Med* 2020;9.
12. Yousef H, Harris BT, Elathamna EN, Morton D, Lin WS. Effect of additive manufacturing process and storage condition on the dimensional accuracy and stability of 3D-printed dental casts. *J Prosthet Dent* 2022;128:1041–1046.
13. Keeling A, Wu J, Ferrari M. Confounding factors affecting the marginal quality of an intra-oral scan. *J Dent* 2017;59:33–40.
14. Ferrari M, Keeling A, Mandelli F, Lo Giudice G, Garcia-Godoy F, Joda T. The ability of marginal detection using different intraoral scanning systems: A pilot randomized controlled trial. *Am J Dent* 2018;31:272–276.
15. Arezoobakhsh A, Shayegh SS, Jamali Ghomi A, Hakimaneh SMR. Comparison of marginal and internal fit of 3-unit zirconia frameworks fabricated with CAD-CAM technology using direct and indirect digital scans. *J Prosthet Dent* 2020;123:105–112.
16. Ng J, Ruse D, Wyatt C. A comparison of the marginal fit of crowns fabricated with digital and conventional methods. *J Prosthet Dent* 2014;112:555–560.
17. Parize H, Dias Corpa Tardelli J, Bohner L, Sesma N, Muglia VA, Cândido Dos Reis A. Digital versus conventional workflow for the fabrication of physical casts for fixed prosthodontics: A systematic review of accuracy. *J Prosthet Dent* 2022;128:25–32.
18. Patzelt SBM, Bishti S, Stampf S, Att W. Accuracy of computer-aided design/computer-aided manufacturing—Generated dental casts based on intraoral scanner data. *J Am Dent Assoc* 2014;145:1133–1140.
19. Yu H, Chen Y hui, Cheng H, Sawase T. Finish-line designs for ceramic crowns: A systematic review and meta-analysis. *J Prosthet Dent* 2019;122:22–30.e5.
20. Dahl BE, Rønold HJ, Dahl JE. Internal fit of single crowns produced by CAD-CAM and lost-wax metal casting technique assessed by the triple-scan protocol. *J Prosthet Dent* 2017;117:400–404.
21. Zeltner M, Sailer I, Mühlemann S, Özcan M, Hämmerle CHF, Benic GI. Randomized controlled within-subject evaluation of digital and conventional workflows for the fabrication of lithium disilicate single crowns. Part III: Marginal and internal fit. *J Prosthet Dent* 2017;117:354–362.
22. Papadiochou S, Pissiotis AL. Marginal adaptation and CAD-CAM technology: A systematic review of restorative material and fabrication techniques. *J Prosthet Dent* 2018;119:545–551.
23. Mangano FG, Admakin O, Bonacina M, Lerner H, Rutkunas V, Mangano C. Trueness of 12 intraoral scanners in the full-arch implant impression: A comparative in vitro study. *BMC Oral Health* 2020;20:263.

24. Rutkūnas V, Gečiauskaitė A, Jegelevičius D, Vaitiekūnas M. Accuracy of digital implant impressions with intraoral scanners. A systematic review. *Eur J Oral Implantol* 2017;10(suppl 1):101–120.
25. Gimenez-Gonzalez B, Hassan B, Özcan M, Pradies G. An in vitro study of factors influencing the performance of digital intraoral impressions operating on active wavefront sampling technology with multiple implants in the edentulous maxilla. *J Prosthodont Off J Am Coll Prosthodont* 2017;26:650–655.
26. Cetik S, Bahrami B, Fossoyeux I, Atash R. Adaptation of zirconia crowns created by conventional versus optical impression: In vitro study. *J Adv Prosthodont* 2017;9:208–216.
27. Re D, Cerutti F, Augusti G, Cerutti A, Augusti D. Comparison of marginal fit of Lava CAD/CAM crown-copings with two finish lines. *Int J Esthet Dent* 2014;9:426–435.
28. Bernauer SA, Müller J, Zitzmann NU, Joda T. Influence of preparation design, marginal gingiva location, and tooth morphology on the accuracy of digital impressions for full-crown restorations: An in vitro investigation. *J Clin Med* 2020;9:3984.
29. Tsirogiannis P, Reissmann DR, Heydecke G. Evaluation of the marginal fit of single-unit, complete-coverage ceramic restorations fabricated after digital and conventional impressions: A systematic review and meta-analysis. *J Prosthet Dent* 2016;116:328–335.e2.
30. Hasanzade M, Shirani M, Afrashtehfar KI, Naseri P, Alikhasi M. In vivo and in vitro comparison of internal and marginal fit of digital and conventional impressions for full-coverage fixed restorations: A systematic review and meta-analysis. *J Evid Based Dent Pract* 2019;19:236–254.
31. Alammam A, Kois JC, Revilla-León M, Att W. Additive manufacturing technologies: Current status and future perspectives. *J Prosthodont* 2022;31(suppl 1):4–12.
32. Huang G, Wu L, Hu J, Zhou X, He F, Wan L, et al. Main applications and recent research progresses of additive manufacturing in dentistry. *BioMed Res Int* 2022;2022:5530188.
33. Khorsandi D, Fahimipour A, Abasian P, et al. 3D and 4D printing in dentistry and maxillofacial surgery: Printing techniques, materials, and applications. *Acta Biomater* 2021;122:26–49.
34. Greco GB, Popi D, Di Stefano DA. Accuracy of 3-dimensional printing of dental casts: A proposal for quality standardization. *J Prosthet Dent* 2022;127:899–910.
35. Auškalnis L, Akulauskas M, Jegelevičius D, Simonaitis T, Rutkūnas V. Error propagation from intraoral scanning to additive manufacturing of complete-arch dentate models: An in vitro study. *J Dent* 2022;121:104136.
36. Yilmaz B, Donmez MB, Kahveci Ç, et al. Effect of printing layer thickness on the trueness and fit of additively manufactured removable dies. *J Prosthet Dent* 2022;128:1318.e1–e9.
37. Johansson C, Dibes J, Rodriguez LEL, Papia E. Accuracy of 3D printed polymers intended for models and surgical guides printed with two different 3D printers. *Dent Mater J* 2021;40:339–347.
38. Park JM, Jeon J, Koak JY, Kim SK, Heo SJ. Dimensional accuracy and surface characteristics of 3D-printed dental casts. *J Prosthet Dent* 2021;126:427–437.
39. Zhang ZC, Li PL, Chu FT, Shen G. Influence of the three-dimensional printing technique and printing layer thickness on model accuracy. *J Orofac Orthop* 2019;80:194–204.
40. International Organization for Standardization. ISO 12836:2015. Dentistry—Digitizing devices for CAD/CAM systems for indirect dental restorations—Test methods for assessing accuracy.
41. Subasi G, Ozturk N, Inan O, Bozogullari N. Evaluation of marginal fit of two all-ceramic copings with two finish lines. *Eur J Dent* 2012;6:163–168.
42. 3Shape TRIOS - Crown Workflow, 2020. Accessed September 28, 2023. Available from: [https://www.youtube.com/watch?v=rIQ2j\\_YhR2U](https://www.youtube.com/watch?v=rIQ2j_YhR2U)
43. Joda T, Matthisson L, Zitzmann NU. Impact of aging on the accuracy of 3D-printed dental models: An in vitro investigation. *J Clin Med* 2020;9:1436.
44. Koulivand S, Ghodsi S, Siadat H, Alikhasi M. A clinical comparison of digital and conventional impression techniques regarding finish line locations and impression time. *J Esthet Restor Dent* 2020;32:236–243.
45. Park ME, Shin SY. Three-dimensional comparative study on the accuracy and reproducibility of dental casts fabricated by 3D printers. *J Prosthet Dent* 2018;119:861.e1–e7.
46. Nestler N, Wesemann C, Spies BC, Beuer F, Bumann A. Dimensional accuracy of extrusion- and photopolymerization-based 3D printers: In vitro study comparing printed casts. *J Prosthet Dent*. 2021;125:103–110.
47. Unkovskiy A, Bui PHB, Schille C, Geis-Gerstorfer J, Huettig F, Spintzyk S. Objects build orientation, positioning, and curing influence dimensional accuracy and flexural properties of stereolithographically printed resin. *Dent Mater Off Publ Acad Dent Mater* 2018;34:e324–e333.
48. Sherman SL, Kadioglu O, Currier GF, Kierl JP, Li J. Accuracy of digital light processing printing of 3-dimensional dental models. *Am J Orthod Dentofac Orthop* 2020;157:422–428.
49. A New E4 lab scanner is released - 3Shape Press. Accessed September 19, 2023. Available from: <https://www.3shape.com/en/press/2019/double-up-your-labs-scanning-speed-and-accuracy>